

Influence of the mesophases on the mechanical properties of three-phase composites

P. S. THEOCARIS, T. P. PHILIPPIDIS

Department of Engineering Science, Athens National Technical University, P.O. Box 77230, P. Phalero (GR175-10), Athens, Greece

The coating of fibres of soft median layers, in order to reduce stress concentrations, and/or singularities at their common interface with the surrounding matrix material, is one of the most efficient methods of improving strength characteristics of fibrous composites. In this paper, the mechanical properties of such a composite system were investigated by means of an improved model taking into account the mesophase layers, i.e. the zones of physico-chemical and mechanical disturbance of an active phase by the presence of another. The mechanical properties, as well as the extent of these mesophases, were also determined for a given three-phase composite. The characterization of the mechanical properties of the two mesophases may prove useful in estimations concerning fracture toughness of such systems.

1. Introduction

Experimental and theoretical work of the last decade concerning the mechanical properties of fibrous composites, has shown increased improvement of the toughness of such substances in the case for which the fibre was surrounded by a material softer than the polymeric matrix, i.e. when the interfacial shear strength around the fibre was decreased [1-5].

However, although the toughness was increased by such fibre coatings a dramatic decrease of tensile strength characteristics was observed in many of these experimental investigations. Then, intermittent bonding control layers [2] or thermoplastic coatings [4], and also other alternatives were proposed in order to obtain a balance between strength and toughness characteristics.

A combination of materials is commonly used in order to prepare such coating layers which also contain chemically active substances such as silanes or other coupling agents in order to control the role of chemical bonding in the adhesion between phases [6]. The contribution of the coating in the improvement of the mechanical properties of the composite is accomplished by the following fundamental operations. Firstly it controls the fibre and matrix debonding and prevents direct fibre contact resulting in a reduction of local matrix strain and secondly reduces the possibilities for propagation of cracks between matrix and fibres. Apart from these features, the mechanical properties of the composite system are also greatly influenced by the quality of adhesion between the matrix, the median layers and the fibres.

It is worthwhile noting that in all the above-cited references perfect adhesion was assumed between such constituent phases as the matrix resin, the fibre and the median layer, a fact which certainly optimizes the real situation. Thus, these models neglect to consider the influence of the boundary layers developed between the three main phases, during the preparation

of the composite and which constitute the main factor controlling adhesion. Clearly, the reported decrease in tensile strength is not only due to the weak interface, i.e. the median layer, having a small shear strength, but it is also intimately related to the poor adhesion between the fibre and the low-modulus polymer, as it is the median-layer material.

During preparation of an impregnated composite system, the coating material in the regions of contact with the fibre and the matrix forms two mesophases. Thus, the representative volume element (RVE) of such composites, according to the improved Hashin-Rosen model [7] is a five-phase cylinder. Then, in order to predict the elastic moduli of the composite one has to expand the already existing solutions to the sequence of five successive phases but there is also the difficulty that two of the phases among the five, are of unknown mechanical properties and geometrical extent.

A theoretical model taking into account the existence of these mesophases was proposed in this paper and the analytical formulation follows that of our previous publications on this subject. This means that the mechanical properties of the mesophase are again assumed to change continuously from those of the fibre to those of the ductile median phase by means of the so-called unfolding models [8, 9]. Then, the extents of the mesophases can be either calculated by means of a theoretical model introduced in [10] together with experimental data concerning the longitudinal elastic modulus, E_c , of the composite, or they can be directly evaluated by dynamic measurements of the loss and storage moduli, E_c'' and E_c' , without recourse to theoretical models [11]. Anyway, both methods were already proved to yield satisfactory results for the extent of the mesophase in the case of a three-phase fibrous composite when theoretical predictions were compared with experimental data obtained by calorimetric measurements of the existing jumps in heat

capacity, ΔC_p , at the glass transition temperature, T_g , of the polymeric composite and matrix [9, 12, 13].

However, for the problem treated in this paper, attention should be paid to the different character of the two mesophases which influences drastically the cooperation of the three main phases of the five-phase composite and contributes differently to the mechanical behaviour of the system.

2. The mesophase layers

2.1. The particular character of the two mesophases

In filled polymers the terms interphase or mesophase denote the hybrid phase of the boundary polymeric layers developed between the filler and the matrix. In this zone around the inclusion a different molecular packing density of the polymer than that of the bulk matrix material is observed and the motion of segmental and larger kinetic elements of polymer chains is restricted by the presence of the filler [14, 15]. Experimental techniques, such as nuclear magnetic resonance (NMR), dielectric relaxation studies and others, indicated the effect in molecular mobility of the change in conformation of polymer chains, because of the geometrical restriction imposed by the surface of the filler [14, 16].

Moreover, adsorption of the polymer macromolecules on the high-energy surface of the solid, together with chemical bonding shrinkage and stress singularities, characterize the local disturbance of the polymer of the filler.

Because of these bounding polymeric layers, which are related to several complicated physicochemical phenomena, changes in dynamic mechanical properties of the filled polymers were observed [17], substantiated by an increase or decrease of the glass transition temperature of the composite [18, 19]. Then, by means of these changes the extent of the polymer–filler interaction zone was calculated by introducing some simple theoretical models which are in conformity with such a behaviour [20–22].

A mesophase is formed not only between a polymeric substance and an inorganic solid but there is also ample evidence [5, 16, 23] of creation of such layers between polymeric phases. Of course, the adhesion phenomena at the interface of two polymeric phases are significantly different from those at the interface of a polymer and a solid of high surface energy [16]. There is also adsorption interaction and chemical bonding and the resulting adhesive bond between two polymers is, in many cases, stronger than between a polymer and an inorganic solid.

The transition zone between the two polymers, i.e. the mesophase, is characterized by mixed supermolecular structures and diffusion phenomena as the interpenetration of the segments of polymer chains. In this fact lies the essential difference of the mesophase formed by two polymers and that formed by a polymer and an inorganic solid, i.e. in the former case the hybrid phase is formed by two components simultaneously because of their mutual diffusion at the layers close to their interface.

2.2. Mathematical modelling of the mechanical properties of the mesophase

In the case of mesophases developed between polymeric and inert phases the thickness of the mesophase was evaluated experimentally in a series of papers [6, 9, 24], according to a method developed by Lipatov [16], where calorimetric measurements of the existing jumps in the heat capacities, ΔC_p , at the glass transition temperatures, T_g , of the polymeric composite and its matrix were used. Then, because the extent of the mesophase was known, the variation of its elastic modulus, $E_i(r)$, was assumed to unfold from the value E_f , the elastic modulus of the filler, to the value E_m , the elastic modulus of the polymeric matrix. The law of variation of $E_i(r)$ with respect to the polar distance r , from the fibre surface, where $r = r_f$, to the distance $r = r_i$, characterizing the thickness of the mesophase, was given by the so-called unfolding models, where the singularity in the modulus of elasticity, $E_i(r)$, caused by the presence of the filler was simulated by negative powers of the polar distance r . This choice was dictated by the already reported stress singularities when a continuum discontinuity is approached, where, in the expressions for the stress components, a singular term, r^{-i} , was displayed.

Thus, for the variation of the modulus of elasticity of the mesophase between polymer and inorganic filler the following law could be used [9]:

$$E_i(r) = E_f \left(\frac{r_f}{r} \right)^{\eta^*} \left[\frac{r_i - r}{r_i - r_f} \right] + E_m \left[\frac{r_i (r - r_f)}{r (r_i - r_f)} \right] \quad (1)$$

which, as it can be seen, satisfies the unfolding conditions, i.e. $E_i(r = r_f) = E_f$ and $E_i(r = r_i) = E_m$. The values of the exponent η^* are dependent on the thickness of the mesophase and as r_i increases, η^* decreases, \bar{E}_i , the average value of $E_i(r)$ for the thickness Δr of the mesophase, also decreases, resulting in a better adhesion. Thus, the exponent η^* could characterize the quality of adhesion and large values of it are related to poor adhesion. Of course this exponent must not be interpreted as a physical property of the mesophase material, but only as a proportionality factor, depending on the specific situation of the sample tested because, as will be seen in what follows, the value of the longitudinal elastic modulus, E_c , of the composite is needed for the theoretical evaluation of the thickness of the mesophase.

In recent publications, the determination of the thickness of the mesophase was no longer based on calorimetric measurements, but it was calculated by means of a theoretical model [10] according to which the slope of the variation $E_i(r)$ for $r = r_i$ must be zero, or by means of dynamic measurements [11] of the loss and storage moduli of the composite material. The results concerning the thickness of the mesophase, when both theoretical methods were used, are in excellent agreement and thus the procedure presented in [10] will be adopted in the sequel, because this method does not need time-consuming experimental techniques as do the dynamic measurements of the loss and storage moduli of the composite material.

The above-cited considerations, together with Equation 1, may be applied to the case of coated-fibre or sized composites, and they could describe the variation of the mechanical properties of the mesophase formed by the coating polymer and the solid fibre.

When two polymeric substances are in contact, the character of their mesophase is quite different from that previously mentioned. For this case, in which the mesophase is a rather diffuse transition zone, where interpenetration of both polymers occurs, it is reasonable to accept that the law of variation of the modulus $E_j(r)$ must be submitted to the zeroing of the tangent of $E_j(r)$ at both extremities of this boundary layer, i.e. for $r = r_s$ where r_s is the radius of the coating inner-layer and $r = r_j$, r_j being the polar radius indicating the extent of this second mesophase. Then, for this purpose, Equation 1 can no longer be used and the variation of $E_j(r)$ can be simulated by the following model [10]:

$$E_j(r) = E_m + \left[E_s \left(\frac{r_s}{r} \right)^{\eta_1} - E_m \left(\frac{r_s}{r} \right)^{\eta_2} \right] \left(\frac{r_j - r}{r_j - r_s} \right) \quad (2)$$

This equation, which also satisfies the boundary conditions, i.e. $E_j(r = r_s) = E_s$, the elastic modulus of the coating material and $E_j(r = r_j) = E_m$, the elastic modulus of the polymeric matrix, could also be submitted to the zeroing of the slope for $r = r_s$ and r_j , and thus yielding two additional relations for the determination of the two unknown exponents η_1 and η_2 . The physical meaning of these exponents could be interpreted in the same manner as for exponent η^* of Relation 1, i.e. algebraically greater values of η_1 and η_2 correspond to a larger extent of the second mesophase and greater average values of the elastic modulus, \bar{E}_j , and thus worse adhesion. Once again it must be pointed out that in no way could these two exponents represent physical properties of the mesophase material.

The procedure developed in [10] and which is also presented in the sequel for the prediction of the thickness of the mesophase by means of Equation 1 and the experimental value of the elastic modulus, E_c , of the composite for various volume fractions of the filler, v_f , was shown to yield satisfactory results. Comparison of the theoretical results was made with experimental data obtained by calorimetric measurements at the glass transition temperature. Then, once the thicknesses of the two mesophases are calculated by means of the theoretical analysis presented in the next section of this paper and the experimental values of the longitudinal modulus, E_c , all other engineering constants of the composite made by the coated fibres and the polymeric matrix, as the transverse elastic modulus or the Poisson ratios and shear moduli, could be accurately determined. This is quite important, because all the existing theoretical models for the prediction of the values of these engineering constants are based on the assumption of perfect adhesion between phases and thus no effect from these mesophases is accounted for.

3. Modelling of the coated-fibre-matrix composite

During the preparation of a fibrous composite mate-

rial in which the fibres are surrounded by a softer or harder (depending on the desired mechanical features of the composite under fabrication) than the matrix material, the flexible polymeric substances form mesophases at their interfaces. That is, the coating creates a mesophase at its interface with the inorganic fibre and contributes to the creation of the other mesophase in the region of contact with the matrix, which also participates in the formation of the latter.

The representative volume element of this system according to the improved Hashin-Rosin model [7] is composed of five coaxial cylinders. These phases, i.e. the fibre, the coating, the matrix and the two mesophases, are assumed homogeneous and with perfect adhesion between them. Then, in the calculations which follow, for the mesophase materials an average value for the modulus of elasticity was assumed which can be calculated by using Equation 1 or 2. A schematic diagram for the variation of the moduli of elasticity in these two mesophases, as well as the geometric configuration of the five cylinder model, is given in Fig. 1. For clarity, the extent of the two mesophases in this figure is magnified.

It should be mentioned from the beginning that the polar radii r_f , r_i , r_s and r_j are the final radii after all the reaction between inorganic and polymeric phases have attained some kind of equilibrium. Indeed, because the chemical bridge concept for providing adhesion between a polymeric coupling agent and an inert substrate (say a glass fibre) requires only the reactive elements of the coupling agent to act on the respective elements of the inert material and, to a lesser extent, the acid centres of the surface of the inert material to act on the respective elements of the coupling agent, it may be assumed with great approximation that the initial radius of the inert fibre remains unchanged and therefore $r_f^\alpha = r_f^\tau$, where the superscripts α and τ mean initial and final states.

However, for the case of mesophase between the median layer and the matrix, the interface between these polymeric phases becomes a diffuse boundary layer because of the dissolution for the physisorbed elements of the median layer into the matrix phase and the penetration of the matrix resin into the chemisorbed softer polymer layers.

The extent of the diffused mesophase depends on the compromise between the relative magnitudes of the entropy and energy contribution of the free energy. Then, the mesophase becomes an interfacial zone corresponding to a fraction of the system volume whose extent, to a first approximation, is a function only of the product of the copolymer molecular weight, M_c , and a measure of the segmental interactions depending on the solubility parameter difference expressed by $(\delta_s - \delta_m)$ where δ_s and δ_m are the segment types of the two phases ($s =$ median layer, $m =$ matrix).

For systems with high molecular weight and large segmental interaction, the interfacial zone tends to zero and a sharp interface exists between phases indicating poor adhesion. For low M and segmental interaction, the interfacial zone may extend all over both phases which now become a unique copolymer

Figure 1 The five-phase fibrous composite model.

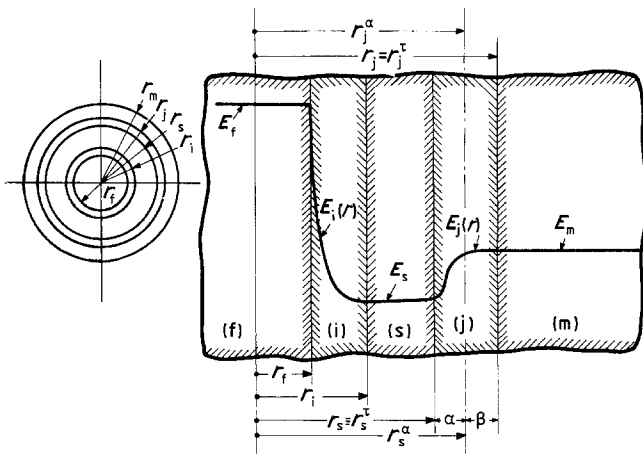

with different properties from the two phases. For systems with intermediate situations, as they are phases in polymer composites, the interfacial zone may exist as a third phase inbetween the two main phases, whose properties are intermediate to those of these phases and which vary from one extreme value approaching the properties of the one phase to another extreme value corresponding to the properties of the second phase.

The variation of these properties follows, in general, a sigmoid-type law with their extreme value coinciding in value and slope with the constant values of the main phases. This explains the reason why in the unfolding models boundary conditions of the type of zeroing of the derivatives of the quantity with respect to the distance are considered.

Then, because the radii r_s and r_j are the final radii after the expiration of the reaction and they are unknown it is necessary to define the extents of reduction of the external radii r_s^α for the soft median layer and/or the increase of the radius r_j^α to $r_j = r_j^\alpha$. The layer $(r_j^\alpha - r_s^\alpha) = (\alpha + \beta)$ constitutes the external mesophase between the median layer and the matrix and either of these phases contributed to its creation by material extending to thicknesses equal to α and β , respectively.

Because in the $(\alpha + \beta)$ -mesophase zone the diffusion varies from a strong contribution of the s-phase in its vicinity to a strong contribution of the m-phase in its vicinity the $E_j(r)$ -modulus varies according to the sigmoid curve indicated in Fig. 1.

For the prediction of the longitudinal modulus of elasticity, E_c , it may be argued that it could be accurately determined by the following improved rule of mixtures (RoM):

$$E_c = E_f v_f + \bar{E}_i v_i + E_s v_s + \bar{E}_j v_j + E_m v_m \quad (3)$$

where bars above symbols denote average values, and the indices i, j, s, f and m refer to the mesophases between fibre and coating and coating and matrix, to the coating substance, to fibre and to matrix, respectively. The different volume fractions displayed in Equation 3 and which must satisfy the condition:

$$v_f + v_i + v_s + v_j + v_m = 1 \quad (4)$$

are given by the following relations:

$$\begin{aligned} v_f &= \left(\frac{r_f}{r_m}\right)^2; & v_i &= \frac{r_i^2 - r_f^2}{r_m^2} \\ v_s &= \frac{r_s^2 - r_i^2}{r_m^2}; & v_j &= \frac{r_j^2 - r_s^2}{r_m^2} \\ v_m &= \frac{r_m^2 - r_j^2}{r_m^2} \end{aligned} \quad (5)$$

All the displayed polar radii in these Equations and elsewhere refer to the RVE configuration and are also shown in Fig. 1. The average values of the elastic moduli, \bar{E}_i , \bar{E}_j , of the two mesophases figuring in Equation 3 were obtained by integrating Equations 1 and 2 in the appropriate intervals, i.e. (r_f, r_i) for \bar{E}_i and (r_s, r_j) for \bar{E}_j .

For the case of coated fibres treated in this paper, we used the modified two- and three-term unfolding models [10], in order to simulate the phenomena occurring in the fibre-coating and coating-matrix mesophases, respectively. The reason for choosing the modified three-term unfolding model, i.e. Equation 2 for the mesophase formed between two polymers, was the need to emphasize the particular character of this mesophase, which is formed by structural singularities of both constituent phases. Because this model can be submitted to the condition of the zeroing of the slope at both ends of the appropriate interval, i. e. (r_s, r_j) , it can be used for our purposes.

The assumption that the tangent of the variation of $E_i(r)$ must be set equal to zero for $r = r_i$ is a continuity condition, expressing the fact that, as this first mesophase is almost completely created by the coating polymer in the presence of a fibre, it is judicious to accept that layers closer to the polymeric phase should resemble more closely this phase and their properties should vary rapidly as we approach the inert phase of the filler with much higher values of its characteristic properties. Thus, the curve expressing the variation of the mechanical and perhaps chemical [20] properties of this zone must be steep in the close vicinity of the filler, and smooth as it approaches the median-layer interface.

For the second mesophase between the median layer and the matrix polymer, the continuity condition must be applied twice, because both materials contribute to the formation of this transition zone, as explained previously. Then, the conditions cited above

are expressed as:

$$\left. \frac{dE_i(r)}{dr} \right|_{r=r_i} = 0 \quad (6a)$$

$$\left. \frac{dE_j(r)}{dr} \right|_{r=r_s} = \left. \frac{dE_j(r)}{dr} \right|_{r=r_j} = 0 \quad (6b)$$

and by introducing Equations 1 and 2 into Equations 6a and 6b one obtains:

$$\eta^* = 1 + \frac{\ln(E_s/E_f)}{\ln(r_f/r_i)} \quad (7)$$

$$\eta_1 = \eta_2 + \frac{\ln(E_s/E_m)}{\ln(r_j/r_s)} \quad (8)$$

$$\eta_2 = \left[\frac{r_s(E_s - E_m)}{r_j - r_s} + \frac{\ln(E_s/E_m) E_s}{\ln(r_j/r_s)} \right] \frac{1}{E_m - E_s} \quad (9)$$

Thus, the unknown exponents η^* , η_1 and η_2 are now given in terms of the elastic moduli of the different phases and their geometrical characteristics. For average values of the elastic moduli of the two mesophases it is valid that:

$$\begin{aligned} \bar{E}_i &= \frac{1}{r_i - r_f} \int_{r_f}^{r_i} \left\{ E_f \left(\frac{r_f}{r} \right)^{\eta^*} \left(\frac{r_i - r}{r_i - r_f} \right) \right. \\ &\quad \left. + E_s \left[\frac{r_i(r - r_f)}{r(r_i - r_f)} \right] \right\} dr \\ \bar{E}_j &= \frac{1}{r_j - r_s} \int_{r_s}^{r_j} \left\{ E_m + \left[E_s \left(\frac{r_s}{r} \right)^{\eta_1} - E_m \left(\frac{r_s}{r} \right)^{\eta_2} \right] \right. \\ &\quad \left. \times \left(\frac{r_j - r}{r_j - r_s} \right) \right\} dr \end{aligned}$$

and, after some simple algebraic calculations, one has:

$$\begin{aligned} \bar{E}_i &= E_s \left\{ 1 - \frac{r_f}{(r_i - r_f)^2} \left[r_i (\ln r_i - \ln r_f - 1) \right. \right. \\ &\quad \left. \left. + r_f \right] \right\} + \frac{E_f}{(r_i - r_f)^2} \\ &\quad \times \left\{ \frac{\left(\frac{r_f}{r_i} \right)^{\eta^*} r_i^2 - r_i r_f}{1 - \eta^*} + \frac{r_f^2 - \left(\frac{r_f}{r_i} \right)^{\eta^*} r_i^2}{2 - \eta^*} \right\} \quad (10) \end{aligned}$$

$$\begin{aligned} \bar{E}_j &= E_m + \frac{E_s}{(r_j - r_s)^2} \left\{ \frac{r_j}{1 - \eta_1} \left[r_j \left(\frac{r_s}{r_j} \right)^{\eta_1} - r_s \right] \right. \\ &\quad \left. - \frac{1}{2 - \eta_1} \left[r_j^2 \left(\frac{r_s}{r_j} \right)^{\eta_1} - r_s^2 \right] \right\} \\ &\quad - \frac{E_m}{(r_j - r_s)^2} \left\{ \frac{r_j}{1 - \eta_2} \left[r_j \left(\frac{r_s}{r_j} \right)^{\eta_2} - r_s \right] \right. \\ &\quad \left. - \frac{1}{2 - \eta_2} \left[r_j^2 \left(\frac{r_s}{r_j} \right)^{\eta_2} - r_s^2 \right] \right\} \quad (11) \end{aligned}$$

4. Calculation of the extent of the mesophases in a composite with median layers

In the preceding sections it was stated that the median layer creates a transition phase in its common inter-

face with the fibre and contributes to the creation of a second mesophase between two different polymers. The thickness of the coating, $(r_s - r_f)$, is known, because it is applied and controlled during the manufacturing process. Part of the initial quantity of the median-phase material constitutes the volume fraction of the mesophase with the fibre, v_i , and another part of it partly contributes to the volume, v_j , of the second mesophase. In the manufacturing procedure of such a composite, the coating is applied to the fibres and then the whole system is heated until complete curing of the coating material has occurred [6]. After that the matrix polymer is applied to the coated fibres. Then, it is believed that the proportion of the median-phase material contributing in the formation of the j-mesophase is smaller than that of the case for which the two polymers were submitted together, both liquids, into the curing treatment.

However, for approaching material properties, as is the case in [25], where the median layer was a modified Shell Epon 815 epoxy resin and a Shell Epon 828 epoxy resin was used as matrix material, a reasonable assumption is to accept that the j-mesophase is formed by equal contributions of both polymers. Thus, with reference to Fig. 1, the distance α should be equal to β .

Then, for calculation of the extents and the stiffnesses \bar{E}_i , \bar{E}_j , of the two mesophases, two kinds of experiments should be performed. First, a specimen consisting of the fibres of the composite and of the median-layer polymer as matrix material should be examined. Second, the entity consisting of the fibre plus the median phase is considered as a compound fibre and the matrix of the composite takes the place of the matrix of this model.

In the first step, attention should be paid to the fact that the fibre volume fraction, v_f , has to be controlled so that the resulting matrix thickness between neighbouring fibres must be approximately equal to the initial coating thickness of the final three-phase composite. Then, by experimental determination of E_c^i , the stiffness of the first specimen, and following the analytical method of Theocaris [10] it is possible to calculate the extent, r_i , and the mean stiffness, \bar{E}_i , of the first mesophase. The non-linear equation to be solved numerically for this case is simply:

$$E_c^i = E_f v_f + \bar{E}_i v_i + E_s v_s \quad (12)$$

It should be emphasized, that volume fractions of different phases figuring in this relation, are not similar to those of Equation 3, and only for this case are given by the following relations:

$$\begin{aligned} v_f &= (r_f/r_s)^2 \\ v_i &= (r_i^2 - r_f^2)/r_s^2 \\ v_s &= (r_s^2 - r_i^2)/r_s^2 \end{aligned} \quad (13)$$

In the solution of Equation 12, with an unknown variable (the radius r_i of the first mesophase), Equations 7 and 10 must also be used.

Consider now that the extent of the i-mesophase (i.e. the radius, r_i) as well as the mean value, \bar{E}_i , of its stiffness are not altered if we prepare a median-phase

composite, provided that the initial coating thickness, r_s^α , is equal to the thickness of the previous model. After termination of the process of the formation of the j-mesophase, a thickness α of the median phase, as well as a thickness β of the matrix polymer now constitute the total thickness of this mesophase. It can easily be derived that the following relations hold:

$$\begin{aligned} r_s^\alpha &= r_s^r + \alpha \\ r_j - r_s^r &= \alpha + \beta \end{aligned} \quad (14)$$

Generally, it is valid that $\alpha = k\beta$, but for the most common case, also cited above, one has $\alpha \simeq \beta$. It follows from Equations 14 that:

$$r_s^r = r_s = 2r_s^\alpha - r_j \quad (15)$$

Then, after experimental measurement of the stiffness, E_c , of the five-phase composite, numerical solution of Equation 3, after substituting in it Equations 5, 8, 9, 11 and 15, yields the radius r_j of the second mesophase, and consequently the mean value for its stiffness, \bar{E}_j . Again, it must be emphasized that the filler volume content, v_f , of this second specimen is not necessarily the same as in the first.

As soon as values for the radii r_i and r_j are known, all other mechanical constants of the composite with the coated fibres, such as the transverse elastic modulus, or the shear moduli and the Poisson ratios, could be predicted by means of appropriate theoretical models taking into account the existence of the mesophases, without recourse to complicated experiments.

The advantage of our theoretical modelling with respect to other theories, which do not need experimental support in order to predict the effective moduli of the anisotropic composite system, lies in the fact cited above. By means of simple experiments, i.e. the measurement of E_c and E_c^i , one can accurately determine all other components of the stiffness tensor, by taking into account the boundary layers formed between the main phases, and which are neglected in all other related theories.

5. Numerical investigation of the proposed model

It was impossible to find in the open literature complete experimental data concerning the material parameters involved in the numerical solution of Equations 12 and 3. Then, in order to check the stability of our model, as well as to judge the validity of its predictions, a thorough numerical experimentation was undertaken, by assuming realistic values for the stiffnesses E_c^i , and E_c for composites existing in the applications.

As a starting point, we chose the materials used

previously [25], i.e. E-glass fibres of 5 mil (12.7×10^{-5} m) diameter with Union Carbide's A-1100 silane coupling agent, coated by a specially treated Shell Epon 815 epoxy resin. As matrix material, a Shell Epon 828 brittle epoxy resin was used.

In the calculations, three different thicknesses of median layer were used, which are also found in [25]. The stiffnesses, as well as other properties, of the different phases are reported in Table I. For a soft median-layer material, the two extreme values for E_s shown in Table I were assumed. The value $E_s = 0.48263$ GPa, as well as all other mechanical constants figuring in this table, are real parameters of these materials [26].

Then, for the determination of the extent, r_i , as well as of the stiffness, E_i , of the first mesophase, one has to use the sets of Equations 12 to 13, and 7 and 10. The radius r_s^α , displayed in Equations 13, is the initial coating thickness and given the radius of the fibre, r_f , the extent of r_s^α can be controlled by altering the filler volume fraction, v_f . For the three different coating materials, values of which were displayed in Table I, the results are reported in Figs 2 and 3 for radius r_i , and in Figs 4, 5 and 6 for the mean value, \bar{E}_i , of the first mesophase. It should be noted, that the extent of the intervals of the parametric values of E_c^i in all these figures is such that the values of r_i are admissible, i.e. $r_f < r_i < r_s^\alpha$.

The same procedure, but using the appropriate equations was also followed for the determination of the extent and the mechanical characteristics of the second mesophase. For the complete five-phase composite the set of Equations 3, 8, 9 and 11 was used, together with Equations 5 and 15. It was assumed, of course, that the characteristics of the i-mesophase remain intact after the embedding of the coated fibres in the matrix bulk. Then, for some particular value of r_i and \bar{E}_i , corresponding to a prescribed radius r_s^α , the above-mentioned set of equations was solved, and the results are reported in Figs 7 to 9.

In all these figures the variation of r_j with respect to E_c was plotted for all the combinations of r_s^α and E_s , available in Table I, using different values of r_i as parameter. The fibre volume fraction, v_f , was held constant and equal to 0.5 for all cases. The variation of \bar{E}_j with respect to different parameters was negligible, as is the case for \bar{E}_i in Figs 4, 5 and 6, and only different values of E_s influence the mean value \bar{E}_j . Thus, to save space, we only report mean values of \bar{E}_j , corresponding to different E_s :

$$E_s = 0.20684 \text{ GPa} \quad \bar{E}_j \simeq 0.925 \text{ GPa}$$

$$E_s = 0.48263 \text{ GPa} \quad \bar{E}_j \simeq 1.110 \text{ GPa}$$

$$E_s = 1.0342 \text{ GPa} \quad \bar{E}_j \simeq 1.45 \text{ GPa}$$

TABLE I Phase properties used in the numerical experimentation

E-glass fibre (f)	Innerlayer (s)	Matrix (m)
$E_f = 72.395 \times 10^9 \text{ Pa}$	$E_{s1} = 0.20684 \times 10^9 \text{ Pa}$	$E_m = 2.0684 \times 10^9 \text{ Pa}$
$r_f = 63.5 \times 10^{-6} \text{ m}$	$E_{s2} = 0.48263 \times 10^9 \text{ Pa}$	
	$E_{s3} = 1.0342 \times 10^9 \text{ Pa}$	
	$r_{s1}^\alpha = 64.144 \times 10^{-6} \text{ m}$	
	$r_{s2}^\alpha = 64.809 \times 10^{-6} \text{ m}$	
	$r_{s3}^\alpha = 66.203 \times 10^{-6} \text{ m}$	

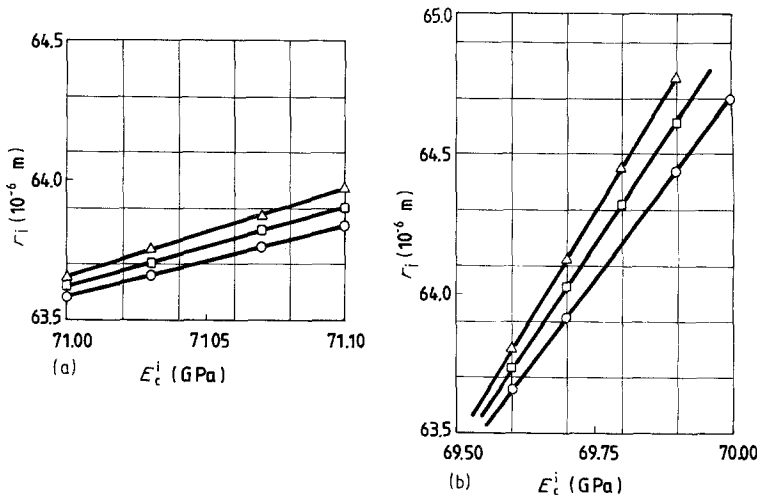

Figure 2 Variation of the extent of the i-mesophase for different innerlayer stiffnesses and various coating thicknesses. (a) $r_s^z = 64.144 \times 10^{-6}$ m, (b) $r_s^z = 64.809 \times 10^{-6}$ m. E_s : (Δ) 0.20684 GPa, (\square) 0.48263 GPa, (\circ) 1.0342 GPa.

The behaviour of the exponent η^* with increasing values of E_c^i , for all cases of different median-layer moduli, E_s , is shown in Figs 4, 5 and 6 as broken lines. The variation of η_1 and η_2 with respect to the value of E_c^i , follows almost the same kind of law as the variation of η^* but in the inverse sense. The two exponents η_1 and η_2 always take negative values, η_1 being absolutely greater than η_2 . Then, for small values of E_c^i , the slope of the curves of η_1 and η_2 remains limited and almost constant, while with increasing E_c^i the slope changes rapidly to very great negative values.

6. Discussion and conclusions

The behaviour of the proposed model of a three-phase composite was exhaustively analysed by means of a thorough numerical investigation and is shown in the figures included in this paper. The following

comments may be made:

1. The extent of the i-mesophase, i.e. the mesophase created by the soft median layer in the presence of the inert E-glass fibre surface, expressed by the radius r_i , increases linearly with increasing values of E_c^i . Because better adhesion between phases is expressed by greater values of E_c^i , it is obvious that, as the extent of the i-mesophase increases, the quality of adhesion becomes better.

2. For the same radius r_i , a median layer of higher elastic modulus results in greater values of E_c^i , and thus, better adhesion. In the same time, it can be observed from Figs 2 and 3 that stiffer median layers form thinner i-mesophases, while the value of E_c^i is kept constant.

3. Although the variation of the mean value of \bar{E}_i with increasing values of E_c^i is negligible, it must be mentioned that thicker i-mesophases possess smaller values of \bar{E}_i . From Figs 4, 5 and 6 one also realizes the obvious fact that the stiffer median layer forms an i-mesophase with a higher elastic modulus. From the same figures it can be deduced that greater values of the exponent η^* result in a worse quality of adhesion.

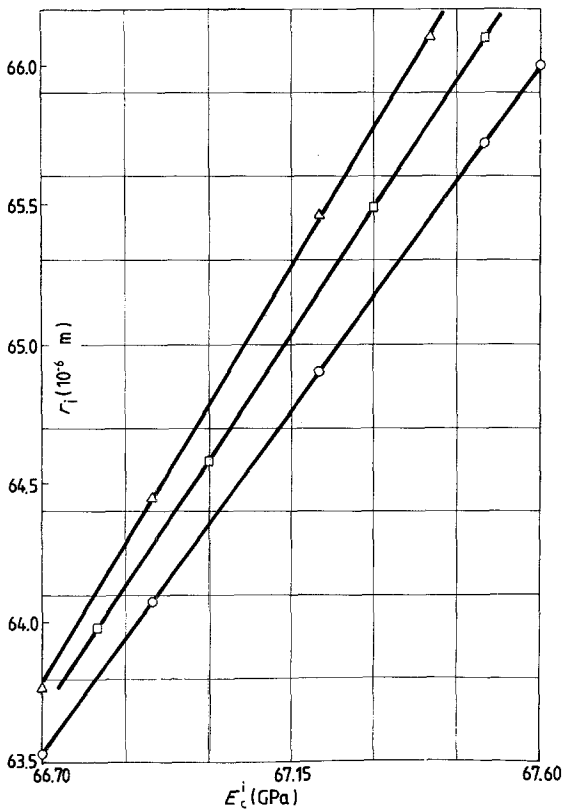

Figure 3 Variation of the extent of the i-mesophase for different innerlayer stiffnesses and various coating thicknesses. $r_s^z = 66.203 \times 10^{-6}$ m. E_s : (Δ) 0.20684 GPa, (\square) 0.48263 GPa, (\circ) 1.0342 GPa.

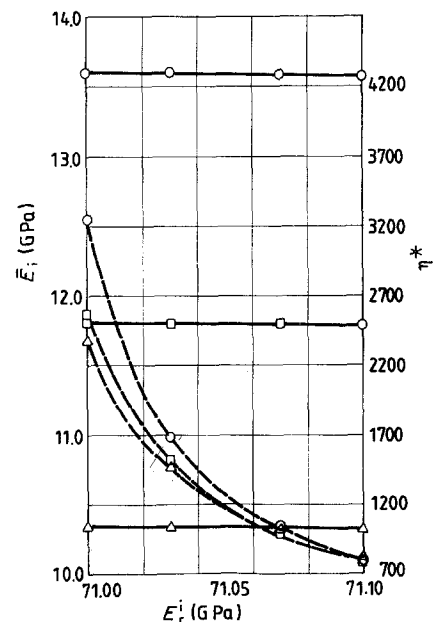

Figure 4 Variation of (—) the mean stiffness, \bar{E}_i , and (---) the exponent η^* of the first mesophase. $r_s^z = 64.1447 \times 10^{-6}$ m. E_s : (Δ) 0.20684 GPa, (\square) 0.48263 GPa, (\circ) 1.0342 GPa.

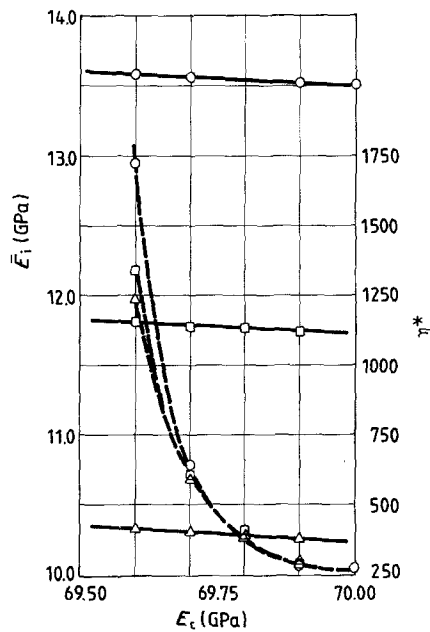

Figure 5 Variation of (—) the mean stiffness, \bar{E}_i , and of (---) the exponent η^* of the first mesophase. $r_s^* = 64.8094 \times 10^{-6}$ m. E_s : (Δ) 0.206 84 GPa, (\square) 0.482 63 GPa, (\circ) 1.0342 GPa.

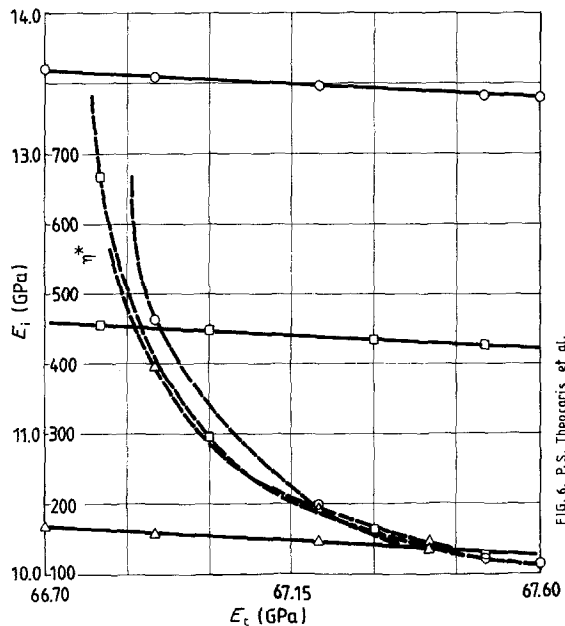

Figure 6 Variation of (—) the mean stiffness, \bar{E}_i , and of (---) the exponent η^* of the first mesophase. $r_s^* = 66.2033 \times 10^{-6}$ m. E_s : (Δ) 0.482 63 GPa, (\square) 0.206 84 GPa, (\circ) 1.0342 GPa.

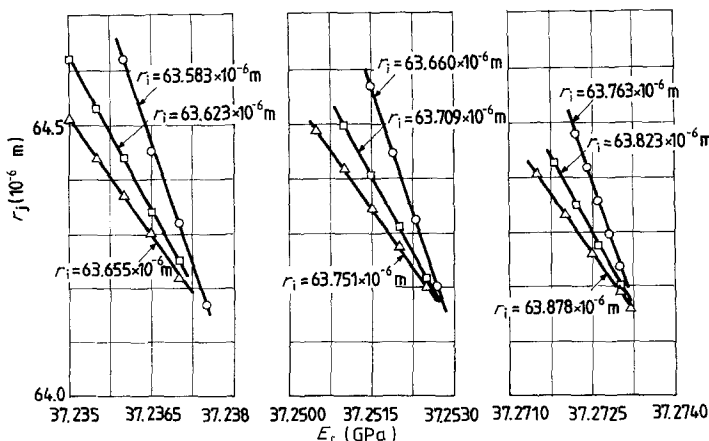

Figure 7 Variation of the extent of the j-mesophase for different innerlayer stiffnesses. $r_s^* = 64.144 \times 10^{-6}$ m. E_s : (Δ) 0.206 84 GPa, (\square) 0.482 63 GPa, (\circ) 1.0342 GPa.

4. Concerning the extent and the characteristics of the j-mesophase formed between the soft median layer and the polymeric matrix, it can be said from the beginning, that it presents exactly the inverse behaviour of the i-mesophase. That is, greater values of E_c correspond to smaller values of r_j , and thus overall adhesion between phases in the five-phase composite, becomes worse with increasing values of r_j . Next, keeping the value of the radius r_j constant, it can be seen, especially in Fig. 7, that for the same median-layer material, greater values of r_i correspond to greater values of E_c , and thus, to better quality of adhesion. Then, it can be stated, that the overall adhesion of the five-phase (three main phases and two mesophases) composite is better as the ratio r_i/r_j increases.

5. For the same radius r_j , the median layer of higher elastic modulus results in greater values of E_c , and thus, better adhesion. However, contrariwise to the i-mesophase, stiffer median layers form thicker j-mesophases, while the value of E_c is kept constant.

6. The values of \bar{E}_i are not influenced by the quality of adhesion or only influenced to a very small degree. Greater negative values of the exponents η_1 and η_2 are also related to a better quality of adhesion.

Many kinds of coatings have been used in order to improve the overall mechanical properties and the toughness of fibrous composites [27]. The experimentation towards this aim continues. It seems that polymeric median layers softer than the polymeric matrix significantly improve the toughness and the tensile (longitudinal and transverse) strength of the composite [25].

Our modelling contributes to the understanding of the character of the two mesophases formed between the three main phases. Therefore, this model may prove useful in calculations concerning the determination of fracture toughness [1]. Fracture almost always occurs in the mesophases and this is proved experimentally by observing the surface of broken fibres. There is always polymeric material attached to these surfaces at different regions, a fact which shows that the fracture path does not follow exactly an "interface". Combined with carefully executed experiments, it will be very interesting in the future to interrelate adhesion and fracture toughness.

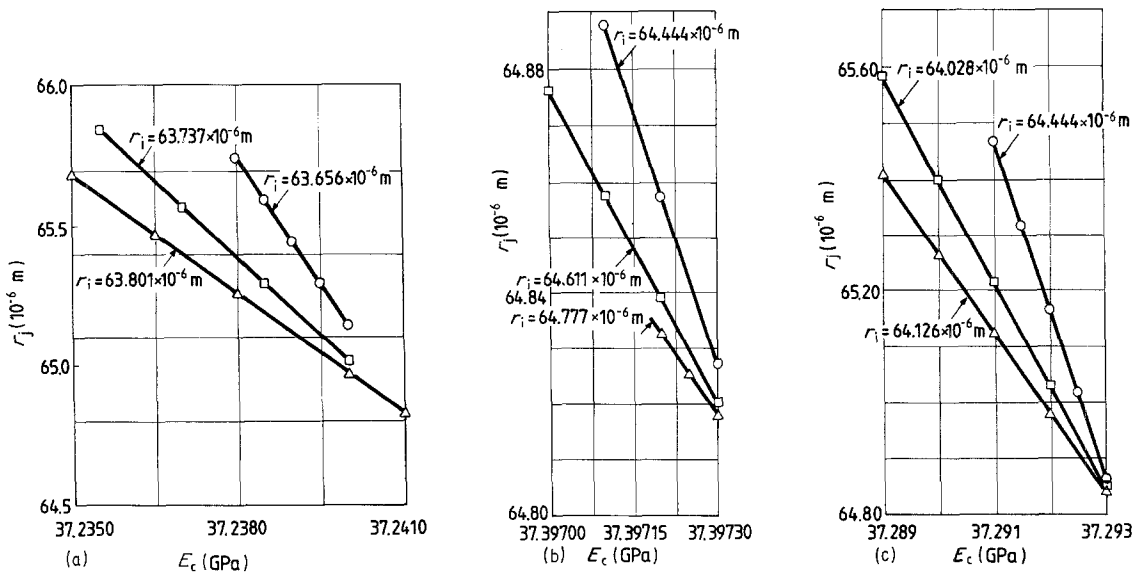

Figure 8 (a-c) Variation of the extent of the j-mesophase for different innerlayer stiffnesses. $r_s^z = 64.8094 \times 10^{-6}$ m. E_s : (Δ) 0.206 84 GPa, (\square) 0.482 63 GPa, (\circ) 1.0342 GPa.

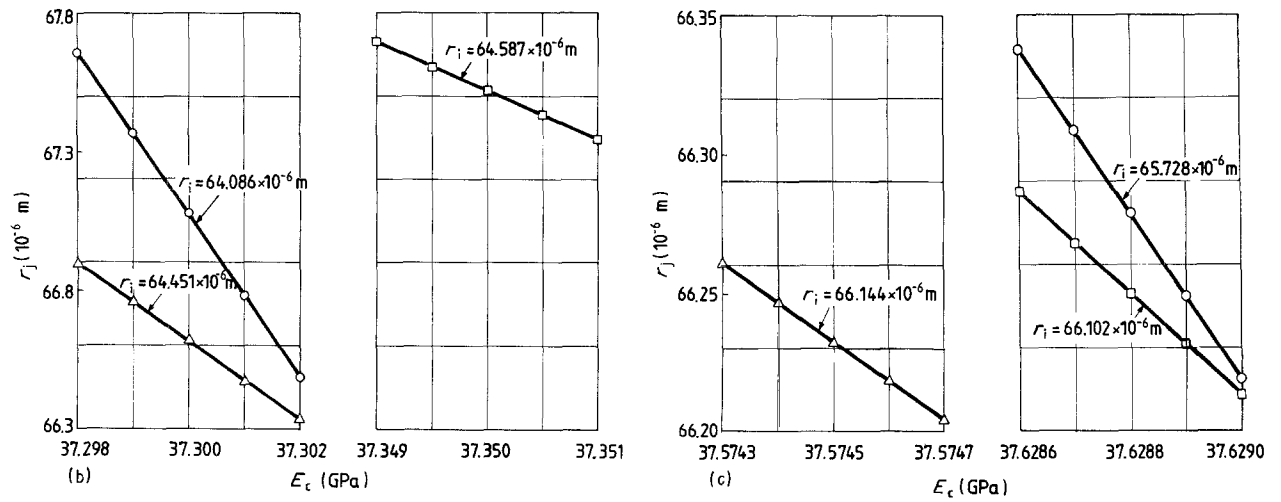
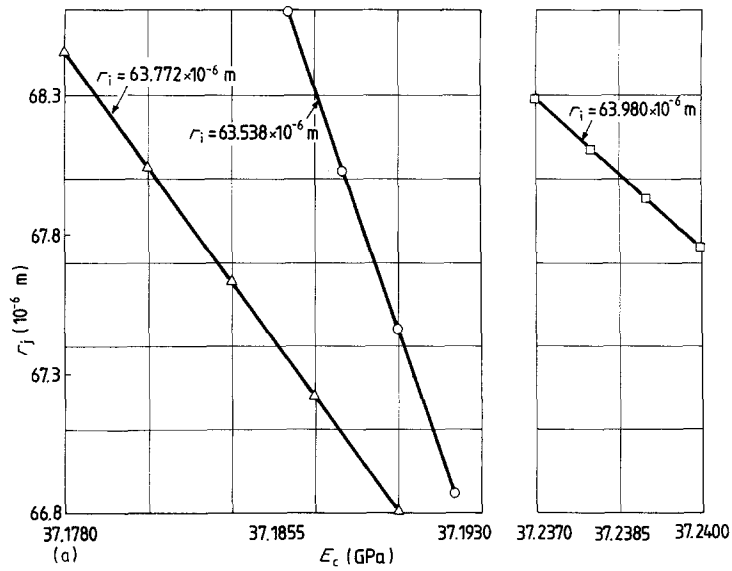

Figure 9 (a-c) Variation of the extent of the j-mesophase for different innerlayer stiffness. $r_s^z = 66.2033 \times 10^{-6}$ m. E_s : (Δ) 0.206 86 GPa, (\square) 0.482 63 GPa, (\circ) 1.0342 GPa.

References

1. T. U. MARSTON, A. G. ATKINS and D. K. FELBECK, *J. Mater. Sci.* **9** (1974) 447.
2. A. G. ATKINS, *ibid.* **10** (1975) 819.
3. N. L. HANCOX and H. WELLS, *Fibre Sci. Technol.* **10** (1977) 9.
4. J. H. WILLIAMS Jr and P. KOUSIOUNELOS, *ibid.* **11** (1978) 83.
5. H. ISHIDA, *Polymer Comp.* **5** (1984) 101.
6. P. S. THEOCARIS, G. C. PAPANICOLAOU and E. P. SIDERIDIS, *J. Reinf. Plastics Comp.* **1** (1982) 92.
7. G. C. PAPANICOLAOU, P. S. THEOCARIS and G. D. SPATHIS, *Colloid Polymer. Sci.* **258** (1980) 1231.
8. P. S. THEOCARIS, *Adv. Polym. Sci.* **66** (1984) 149.
9. *Idem*, *J. Reinf. Plastics Comp.* **3** (1984) 204.
10. P. S. THEOCARIS and T. P. PHILIPPIDIS, *ibid.* **4** (1985) 173.
11. P. S. THEOCARIS, *Colloid Polym. Sci.* **263** (1985) 863.
12. *Idem*, *ibid.* **262** (1984) 929.
13. *Idem*, in "Metal-Filled Polymers: Properties and Applications", edited by S. K. Bhattacharya (Dekker, New York, 1986) Ch. 5, p. 259.
14. Yu. S. LIPATOV and F. Y. FABULYAK, *J. Appl. Polym. Sci.* **16** (1972) 2131.
15. D. H. DROSTE and A. T. DIBENEDETTO, *ibid.* **13** (1969) 2149.
16. Yu. S. LIPATOV, in "Physical Chemistry of Filled Polymers", Translated from the Russian by R. J. Moseley, Int. Polymer Sci. and Tech. Monograph No. 2 ("Khimiya", Moscow, 1977) p. 61.
17. K. IISAKA and K. SHIBAYAMA, *J. Appl. Polym. Sci.* **22** (1978) 3135.
18. C. A. KUMINS and J. ROTEMAN, *J. Polym. Sci.* **A1** (1963) 527.
19. *Idem*, *ibid.* **A1** (1963) 541.
20. T. K. KWEI, *ibid.* **A3** (1965) 3229.
21. K. D. ZIEGEL and A. ROMANOV, *J. Appl. Polym. Sci.* **17** (1973) 1119.
22. *Idem*, *ibid.* **17** (1973) 1133.
23. S. WU, in "Polymer Blends", Vol. 1, edited by D. R. Paul and S. Newman (Academic Press, New York, 1978) Ch. 6, p. 292.
24. G. D. SPATHIS, E. P. SIDERIDIS and P. S. THEOCARIS, *Int. J. Adhesion Adhesives* **1** (1981) 195.
25. L. D. TRYSON and J. L. KARDOS, in 36th Annual Conference, Reinforced Plastics/Composites Institute, The society of the Plastics Industry Inc., Session 2-E (1981) p. 1.
26. J. L. KARDOS, personal communication (1986).
27. J. V. MULLIN and V. F. MAZZIO, *J. Mech. Phys. Solids* **20** (1972) 391.

Received 24 November 1986
and accepted 29 January 1987